

Wynn

Hand Towel Bar

W6580 \_\_\_\_ (specify finish)

LALOO ACCESSORIES

SERVICE@LALOO.CA

866-305-2566

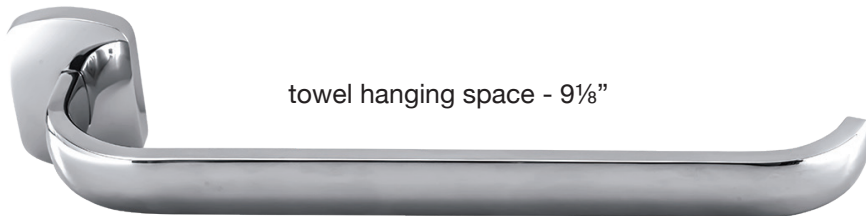



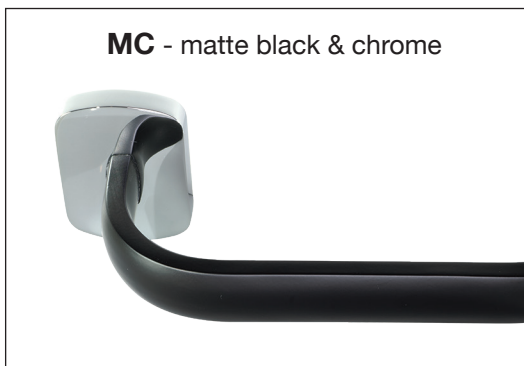

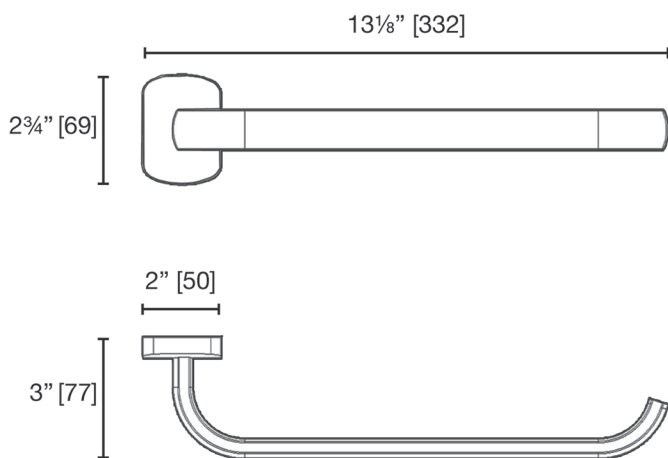

towel hanging space - 9 1/8"

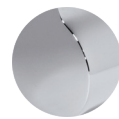
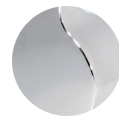
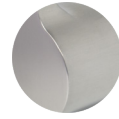

MC - matte black & chrome

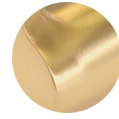

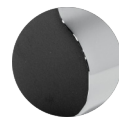
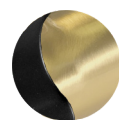
Available Finishes

-  C chrome
-  PN polished nickel
-  BN brushed nickel
-  GD polished gold
-  BG brushed gold
-  MB matte black
-  MC matte black & chrome
-  MG matte Black & brushed gold
-  WF white frost
-  SG stone grey

Complementary Accessories

- robe hook
- single towel bar
- extended double towel bar
- hand towel bar
- paper holder



- single glass shelf



Use metric dimensions for greatest accuracy. Specifications are subject to change without notice.

A CELEBRATION of ART & FUNCTION

# INSTALLING ACCESSORIES

## Anchoring in Drywall

Accessories mounted on drywall need to be firmly anchored or they will eventually loosen. Position the accessory at the desired height and then use an electronic stud finder to locate studs in the area.

If installation on a stud(s) is not possible, install drywall plug(s) for mounting brackets.

If possible, position the accessory so at least one mounting screw can go into a stud and then trace the accessory mounting hole(s) onto the wall.

Level the mounting bracket.

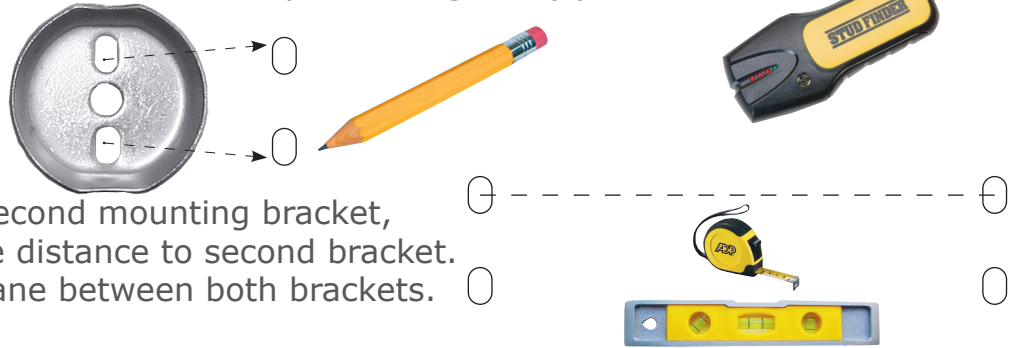

If the accessory requires a second mounting bracket, measure the centre to centre distance to second bracket. Use a level to confirm the plane between both brackets. Trace the mounting hole(s).

Drill or punch appropriate-sized holes for either screws or wall plugs. Install wall plugs as needed.



Attach the accessory firmly to the mounting bracket using set screws. Take care not to over-tighten as they can strip out.

## Anchoring for Additional Support

Please note that some accessories in the LaLOO offering specifically require **support backing**.

Install a 2x4 brace (or a 2x6 brace for grab bar installation) between studs at the predetermined desired height of the accessory.



## Anchoring in Tile

Use tubular plastic anchors (not provided) to hold accessories firmly in place when installing into tile affixed to concrete backer board. Use a carbide glass/ tile bit to drill pilot holds. Tap in the anchors and fasten the mounting bracket with screws. (Use tapered anchors for tile installed on drywall.)

